

KCSC-BP

Mobile Self-Contained Cold Pan Serving Counters

Models

- KCSC-36BP Refrigerated cold pan serving counter, 26" x 21.62" cold pan size
- KCSC-50BP Refrigerated cold pan serving counter, 39" x 21.62" cold pan size
- KCSC-60BP Refrigerated cold pan serving counter, 52" x 21.62" cold pan size
- KCSC-74BP Refrigerated cold pan serving counter, 65" x 21.62" cold pan size
- KCSC-96BP Refrigerated cold pan serving counter, 78" x 21.62" cold pan size



KCSC-50-BP

Standard Features

- On/off switch mounted to exterior of unit
- 10' long cord and plug are standard
- 5" polyurethane swivel casters for easy cleaning
- Easy to use stainless steel interlock system is standard on base and tray slides
- Environmentally friendly R290 refrigerant
- Counters are standard with 7" deep refrigerated cold pan, for use of 4" deep pans. Cold pans are fully insulated with foamed in place environmentally friendly, Kyoto Protocol Compliant, Non ODP (Ozone Depletion Potential), Non GWP (Global Warming Potential) polyurethane insulation
- Pans recessed 2" from top edge of counter
- Enclosed base
- Cold pans are standard with drain with valve
- Electronic temperature control
- 1 year parts and labor standard warranty

Options & Accessories

- Tray slides and work shelves
- 10" wide composite fold-down cutting boards
- Glass-front counter protector
- FlexiShield® Food Shields
- 12" (30cm) wide 18-gauge stainless steel overshef
- Fluorescent or incandescent light fixtures*
- Open understorage with shelf or doors
- 120V/60Hz/1Ø, 10 amp convenience outlet with breaker*
- Dry storage compartment — single or double door
- Refrigerated understorage (60" unit or longer only)*
- Molded fiberglass trim strips
- Stainless steel end drop shelf
- 6" (15cm) high adjustable stainless steel legs
- Adjustable height casters
- Adapter bars (specify length)

* Inclusion of these options will alter the electrical specifications of unit

Specifications

Exterior body is seamless, one-piece molded fiberglass, having perfectly smooth exterior surface with all corners fully rounded. The fiberglass reinforced polyester (F.R.P.) is molded with permanent color. Stress points are internally reinforced.

Exterior top is constructed of 14-gauge stainless steel, welded, ground and polished into one integral unit.

The refrigerated cold pan is 7" (18cm) deep and constructed of stainless steel. The cold pan is separated from the exterior top by a thermal break. Copper refrigeration tubing is attached to the sides of the cold pan and is fully insulated with foamed in place environmentally friendly, Kyoto Protocol Compliant, Non ODP (Ozone Depletion Potential), Non GWP (Global Warming Potential) polyurethane insulation. Cold pan is

equipped with a 1" (2.5cm) I.P.S. drain with drain valve located at the bottom of the unit. Temperatures of 33°F (1°C) to 41°F (5°C) are maintained with pans recessed 2" (5cm) at 86°F ambient room temperature. Pans rest on a stainless steel bracket. Pans by others.

Refrigeration system uses R290 refrigerant and has a self-contained 115 volt, 60 Hertz, single phase hermetically sealed condensing unit with electronic temperature control. Unit is wired with a 3-wire, grounded, maximum 10' (3m) cord and plug. Unit has an on/off switch mounted on the exterior.

Castors: Unit is mounted on 5" (13cm) diameter swivel casters with non-marking polyurethane tires and plate brakes. Overall height of caster assembly is 6.00" (15cm).



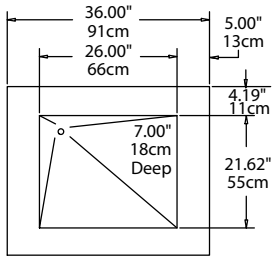

Plan View
KCSC-36-BP

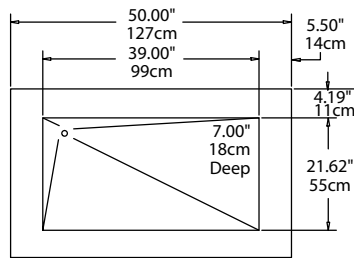

Plan View
KCSC-50-BP

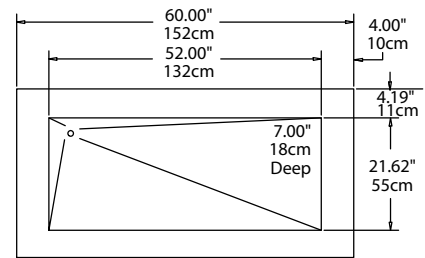

Plan View
KCSC-60-BP

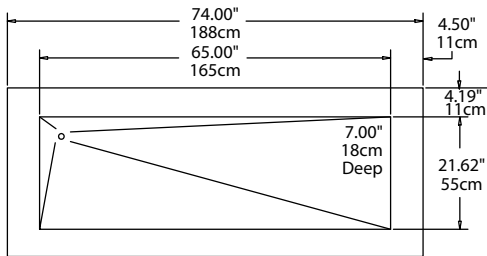

Plan View
KCSC-74-BP

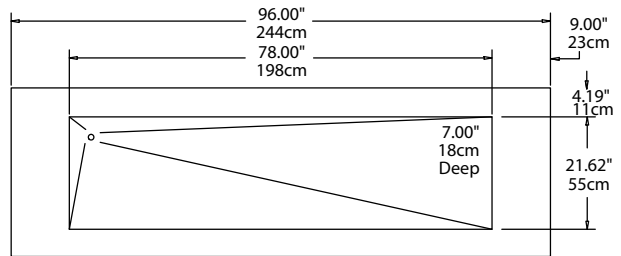

Plan View
KCSC-96-BP

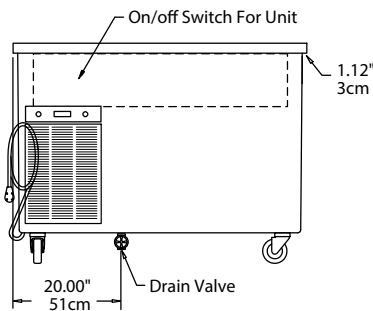

Typical Elevation View
All KCSC-BP Models

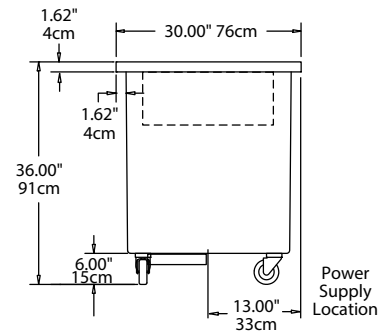

Typical End View
All KCSC-BP Models

KCSC-BP

Specifications								
Model	V/Hz/Ph	Amp	H.P.	BTU Load @ 86F	BTU System Capacity @ 86F	Nema Plug	Ship Weight	"DOE kWh/d (base only)"
KCSC-36-BP	115/60/1	2.4	1/5	405	883	5-15P	350lbs/159kg	n/a
KCSC-50-BP	115/60/1	2.4	1/5	608	1020	5-15P	425lbs/193kg	n/a
KCSC-60-BP	115/60/1	3.7	1/4	810	1356	5-15P	500lbs/227kg	n/a
KCSC-74-BP	115/60/1	3.7	1/4	1013	1489	5-15P	575lbs/261kg	n/a
KCSC-96-BP	115/60/1	4.8	1/3	1215	1943	5-15P	650lbs/295kg	n/a

Welbilt reserves the right to make changes to the design or specifications without prior notice.